

Spherical roller bearings, cylindrical and tapered bore

Principal dimensions			Basic load ratings		Speed ratings		Designation
d	D	B	dynamic C	static C0	Reference speed	Limiting speed	
mm			kN		r/min		* SKF Explorer bearing
110	180	69	539	750	2000	3000	24122 CCK30/W33 *

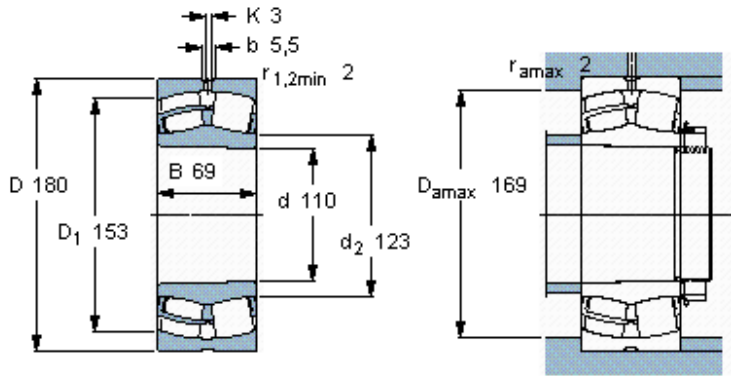

Tapered bore, taper
1: 30

Calculation factors

- e 0,37
- Y_1 1,8
- Y_2 2,7
- Y_0 1,8